

# E5072A ENA Series Network Analyzer

30 kHz to 4.5/ 8.5 GHz

- Versatile
- Fast
- Compatible
- Cost-effective

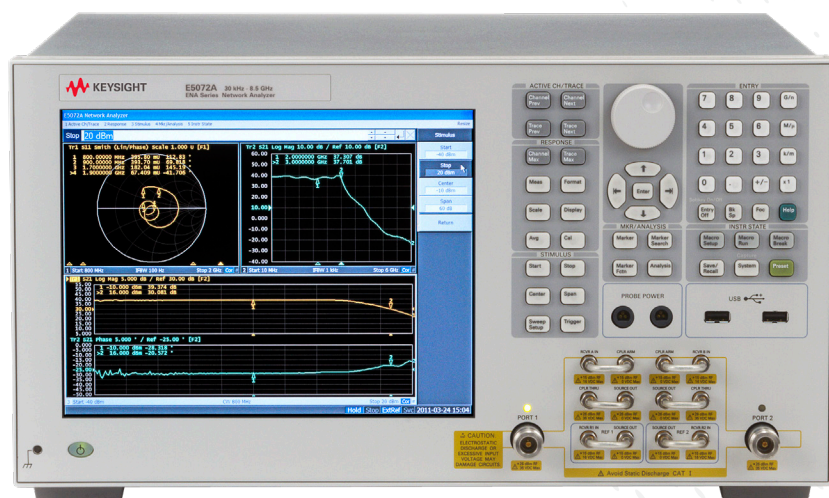

## ENA with Configurable Test Set

- High output power (up to +20 dBm)
- Extended dynamic range (up to 151 dB)
- Fast measurement speed (7 ms @ full 2-port cal, 401 points)

## Intuitive & Powerful User Interface

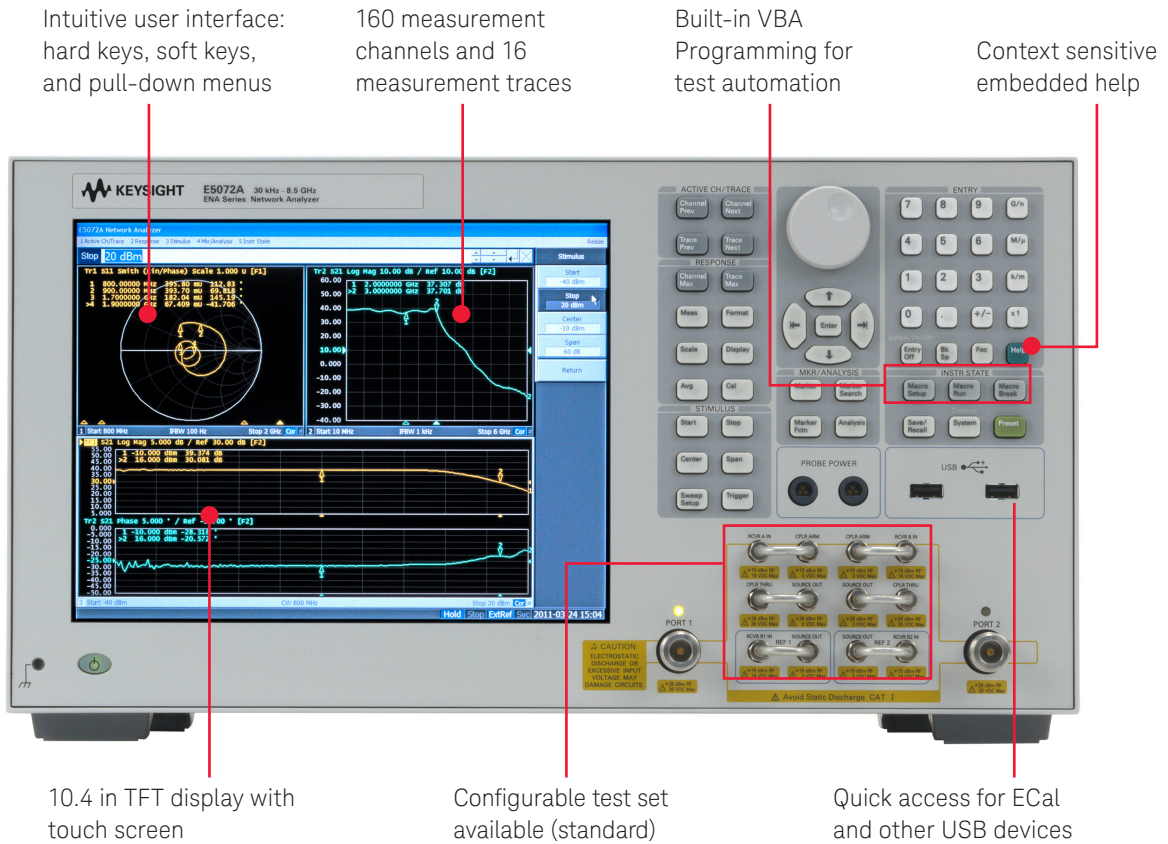

## Flexible setup with configurable test set

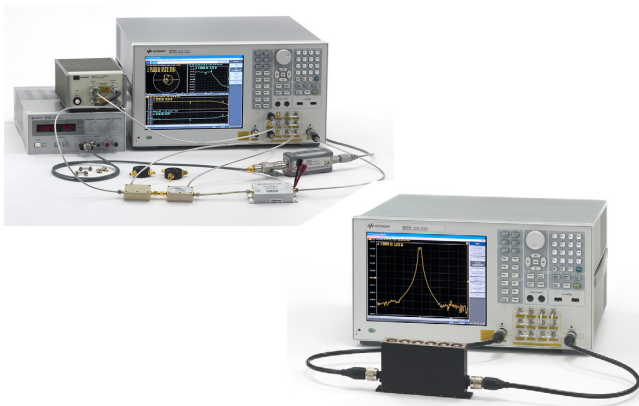

## High output power (up to +20 dBm)



# Connectivity, Flexibility, Usability

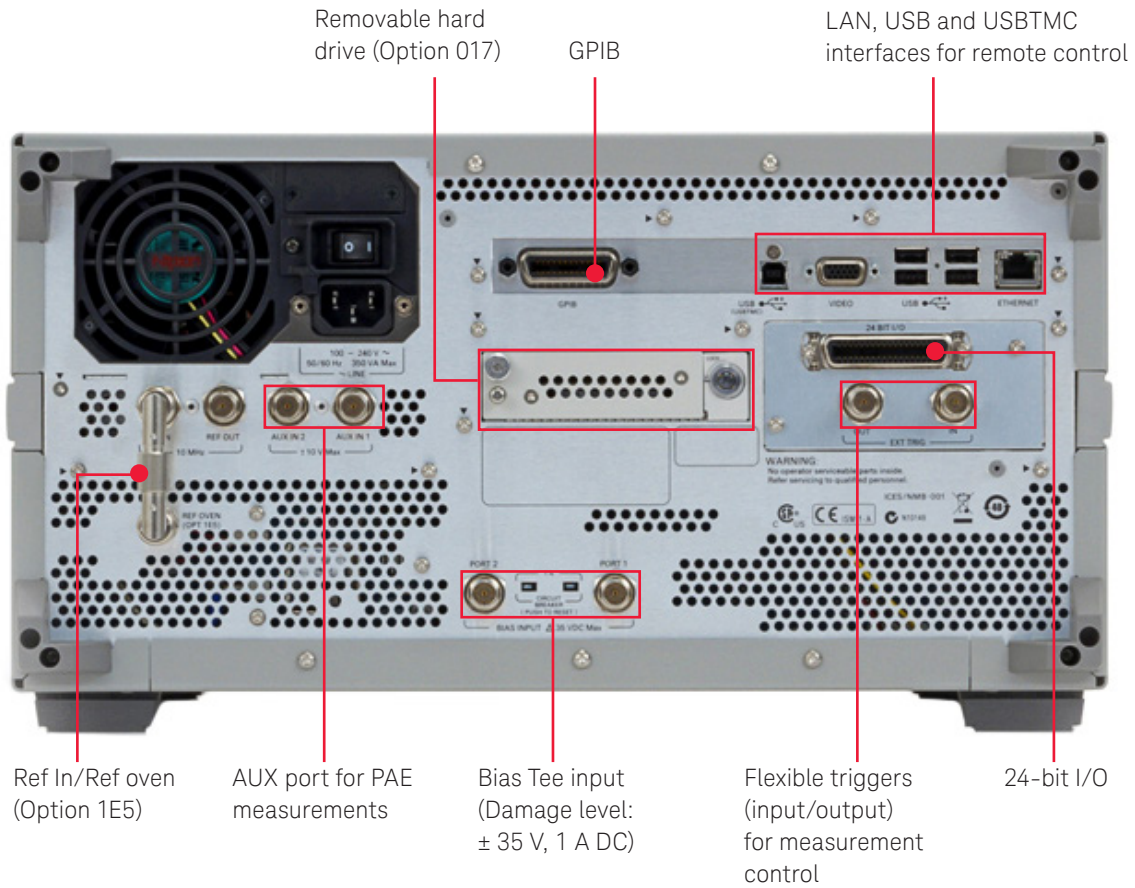

## Extended dynamic range

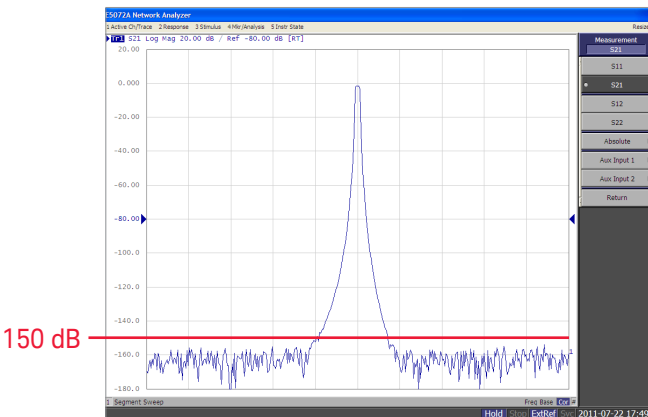

## Fast measurement speed



1601 points, full 2-port cal, 1 to 1.2 GHz, IFBW = 6 kHz (8753ES), 500 kHz (E5071C and E5072A)

## E5072A Overview

The Keysight Technologies, Inc. E5072A ENA Series Network Analyzer is a new addition to the ENA series providing a more flexible platform with enhanced capabilities to meet your evolving measurement needs for a wide range of applications. The improved performance on the E5072A exceeds what is possible with the current RF network analyzers. The E5072A with a configurable test set provides access to the signal paths between the internal source, receivers, bridges, and the analyzer's test ports; which improves instrument sensitivity as well as the ability to add components or peripherals for a variety of applications. The E5072A delivers new standards in versatility, speed and accuracy, and is suitable for full performance characterization of passive and active components, such as antennas, filters, and high-power amplifiers.

Carrying on the ENA series' tradition, the E5072A has all the advantages of the industry-standard RF network analyzer (E5071C) and designed for the most demanding requirements from R&D and manufacturing. The E5072A is versatile, fast, and fully compatible, an all in one solution at an affordable price.

Contact your Keysight sales representative or visit [www.keysight.com/find/e5072a](http://www.keysight.com/find/e5072a) for more information

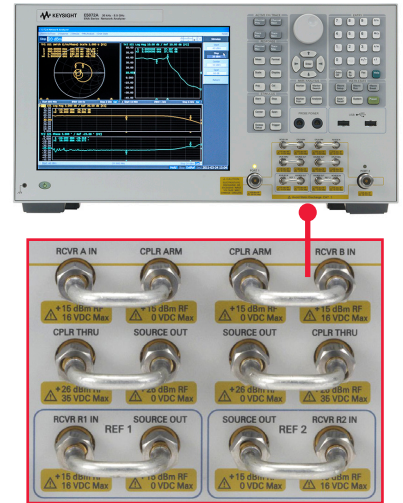

Figure 1. Jumpers on front panel

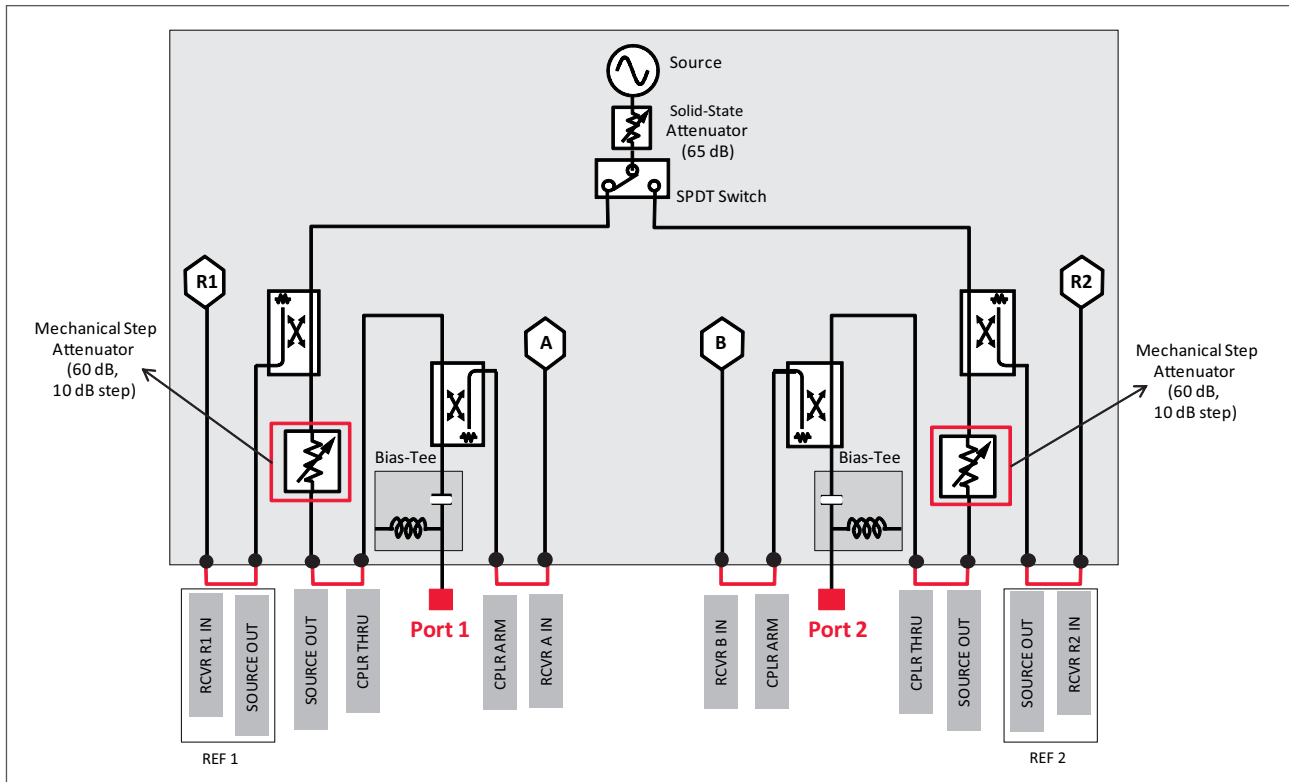

Figure 2. Block diagram of E5072A



## Versatile

Advanced features such as an extremely wide power range, high output power, and direct receiver access capability, provide flexibility to meet your changing and demanding test requirements. You can easily setup any test configuration on the E5072A, to suit your specific applications.

### Application no. 1: High-power measurement

High-power signal measurements are necessary to characterize devices under real conditions. For example, there are passive components (i.e. band pass filters, couplers, isolators, or detectors) installed in front-end modules of wireless communications systems, and these are connected to the output port of power amplifiers on transmission paths. Accurate measurements of these DUTs (device under test) are required when high input is applied to the ports.

For measurements of such devices, the E5072A offers high power output from the test port up to +20 dBm. In addition, the E5072A with configurable test set capability allows you to add components in the source and receiver paths. You can add external booster amplifiers in the source path for increasing the power level to drive your DUT, attenuators or isolators can also be added in the receiver path to prevent any compression or damage of the receivers in the E5072A.

### High output power up to +20 dBm

The E5072A delivers at source power level up to +20 dBm from the test port in the frequency range of 300 kHz to 1 GHz.<sup>1</sup> The E5072A operates in a broad frequency range from 30 kHz to 4.5 GHz (Option. 245) or 8.5 GHz (Option 285) and guarantees high-power measurements with excellent impedance match with error correction. In this case, additional equipment costs such as booster amplifiers are eliminated with the E5072A

The E5072A has a 65 dB power sweep range (i.e. -49 to +16 dBm in 300 kHz to 3 GHz) with specified leveled power that allows measurements of compression characteristics on active devices without any additional amplifiers. Characterization of linear and nonlinear regions of your active devices can be achieved with a single power sweep.

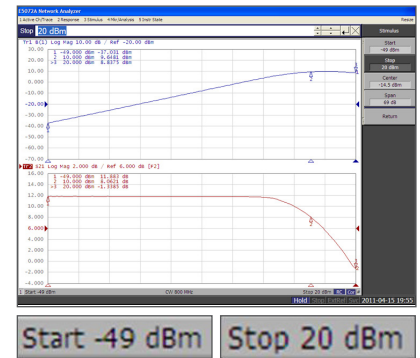

Figure 3. Widest power sweep range n class (ex. settable from -49 dBm to +20 dBm)

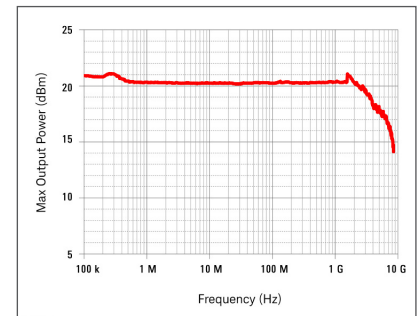

Figure 4. Typical performance of max output power level of the test port of the E5072A

# Versatile

## Direct receiver access to boost power

For applications that require a specific output power higher than the E5072A provides, an external amplifier is necessary in order to boost the power level to the input of the DUT. By using an external amplifier, you can physically position the amplifier closer to your DUT to reduce cables loss and achieve higher power at the DUT. The problem with using an external booster amplifier is the errors associated with temperature drift from the amplifier. These errors cannot be removed since the reference signal is measured before the booster amplifier. Also, the high reverse isolation of a booster amplifier will prevent accurate reflection measurements of the DUT.

In order to overcome the drift effect of a booster amplifier, the E5072A gives you direct access to all source and receiver paths to add external components for a variety of applications such as high-power amplifiers and, directional couplers. By using external couplers, the incident signal can be measured in the reference receiver (R1) of the E5072A after the booster amplifier rather than before, which cancels the effect of temperature drift and improves measurement uncertainty. All calibration techniques are available with this configuration, and high accuracy and long-term stability of measurements are guaranteed.

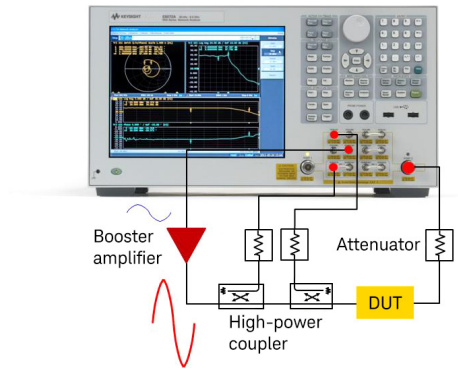
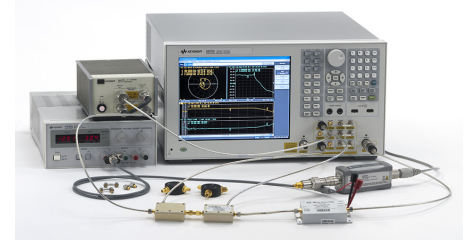
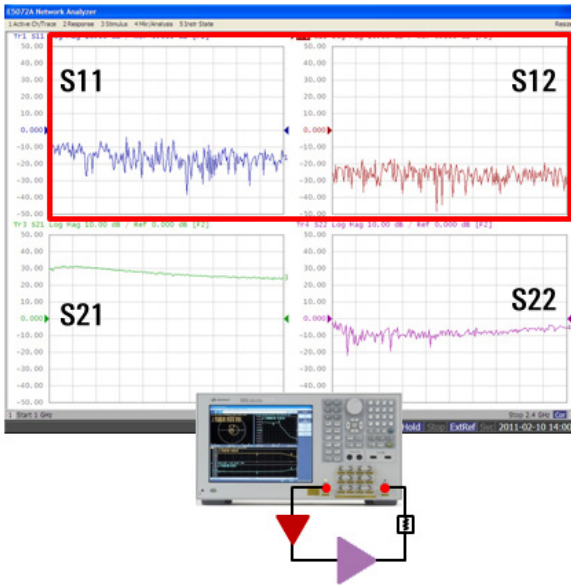

Figure 5. Configuration example using direct receiver access



Standard 2-port configuration



Configuration with direct receiver access

Figure 6. Amplifier measurements with high-power input using a booster amplifier

## Versatile

### Application no. 2: Low-power measurements

In many wireless communication standards, the power level of the input signal to the receiver is specified and performance of the receiver sensitivity needs to be guaranteed. To characterize components in the receiver path such as band-pass filters or low-noise amplifiers, it is often required to measure S-parameters using very low signals to simulate real conditions. The built-in attenuators on each port of the E5072A allow you to perform accurate S-parameter measurements with extremely low signals,  $-85$  dBm or below.

### Accurate measurements

As the signal for the reference receiver (R1 or R2) is picked up at the internal bridges of the E5072A before the source attenuator, adequate S/N (signal-to-noise) ratio is achieved resulting in stable and accurate S-parameter measurements using low signals. In addition, built-in attenuators on the E5072A's source paths eliminate the need for external attenuators. Comparing the measurement results the E5072A offers a significant advantage providing for more accurate reflection and transmission measurements of with very low output power.

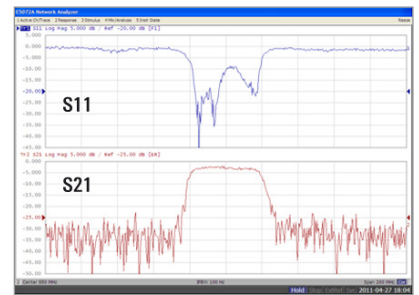
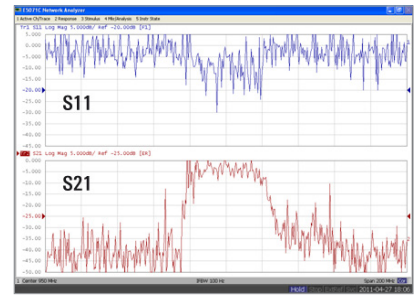

Figure 7. Accurate measurements with low signal input, Upper (power =  $-55$  dBm with external 20 dB attenuator), Lower (power =  $-75$  dBm with built-in attenuator)

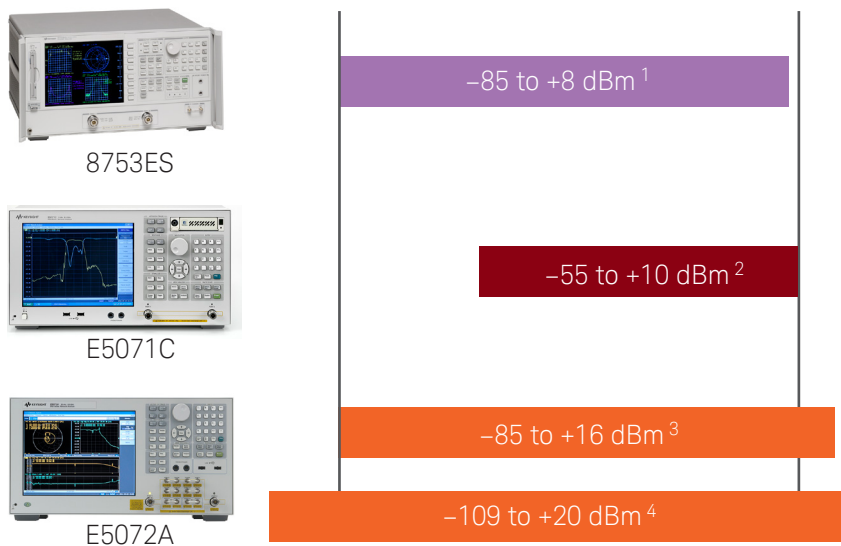

Figure 8. Standard source attenuators of E5072A offer an extremely wide power range

1. Leveled output power specified at test port of the 8753ES Option 014 (configurable test set).
2. Leveled output power specified at test port from 9 k to 5 GHz.
3. Leveled output power specified at test port from 300 k to 3 GHz.
4. Settable output power range.

# Versatile

## Uncoupled power

The E5072A has two built-in source attenuators on each port and the attenuation can be changed independently, allowing for uncoupled power level for port 1 and port 2. Uncoupling port power is useful when measuring high-gain amplifiers with a very low signal input to the DUT. When low-power level is supplied from port 1 of the E5072A to the input of the amplifiers in the forward direction, the higher output power level can be set from port 2 to increase dynamic range in the reverse direction. This gives more accurate results with full 2-port calibration to test reverse isolation ( $S_{12}$ ) of the DUT. Full 2-port calibration uses all four S-parameters ( $S_{11}$ ,  $S_{21}$ ,  $S_{12}$  and  $S_{22}$ ), thus it is critical to make sure that all the S-parameters are accurate. Since low-power input from port 1 can eliminate additional external attenuators on port 2 to protect the E5072A receivers from damage, this can also improve accuracy of reverse reflection ( $S_{22}$ ) measurements.

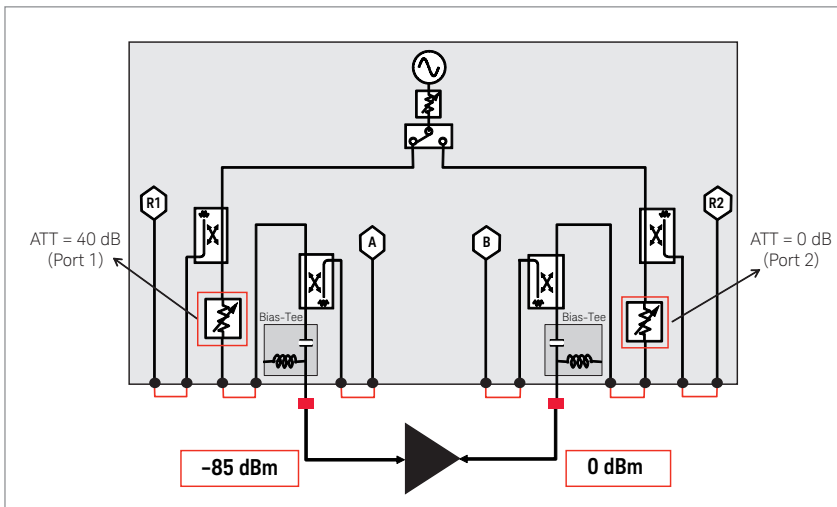
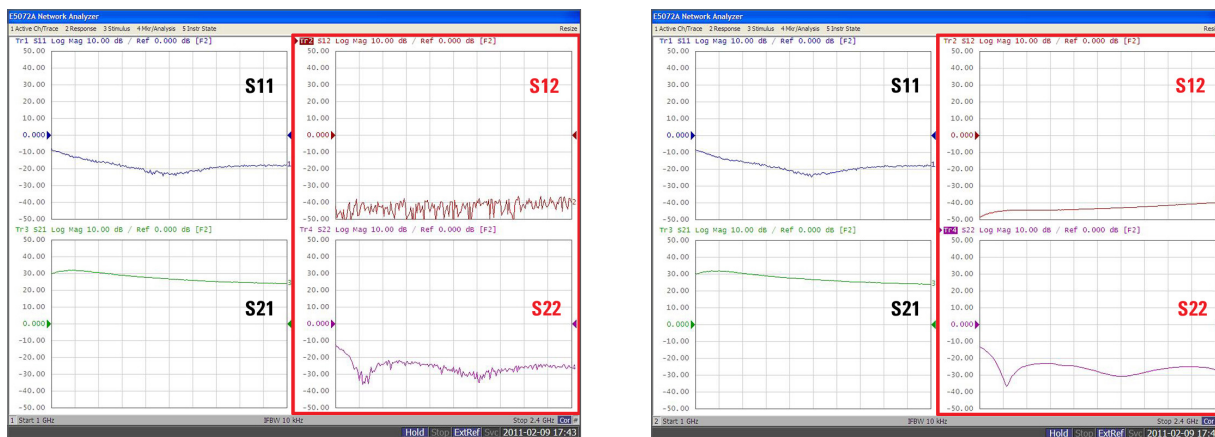

Figure 9. Uncoupled output power with independent source attenuators



Coupled power  
(Port 1 = Port 2 = -40 dBm)

Uncoupled power  
(Port 1 = -40 dBm, Port 2 = 0 dBm)

Figure 10. Uncoupled power improved the accuracy of measurement of high-gain amp



# Versatile

## Application no. 3: Wide dynamic range

### High-rejection measurements

The E5072A's direct receiver access capability enables you to reverse the signal path in the test port couplers and bypass the loss associated with the coupled arm. Using this configuration, you can increase the forward measurement receiver sensitivity by more than 20 dB. Combined with the segment sweep, the dynamic range in the forward measurement of the E5072A can be reached as wide as 150 dB. The segment sweep with the E5072A is recommended for this configuration, because the appropriate source power level can be selected to maximize dynamic range and avoid compression at receiver ports. This configuration should only be used when the receiver input will never exceed its damage level. For devices such as high-rejection filters, the segment sweep should be performed with a segment table where the source power level of the E5072A is set to high in the stop band, and low in the pass band of the DUT. This configuration is beneficial for accurately measuring very low signal levels, such as rejection bands of filters or isolation of RF switches.

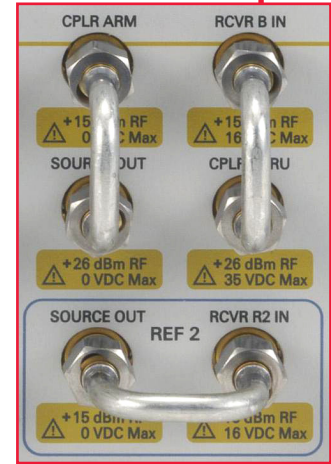
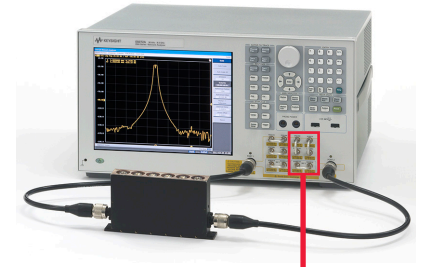

Figure 11. Wide dynamic range of forward measurements can be achieved with an alternative configuration using jumpers

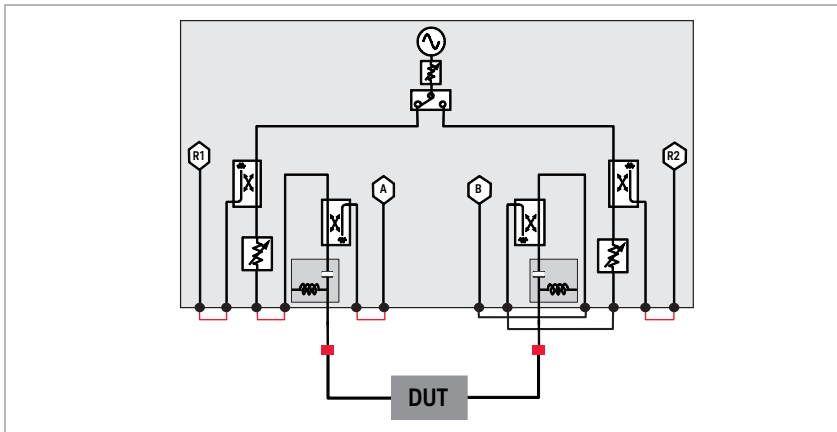

Figure 12. Block diagram of the configuration with wide dynamic range

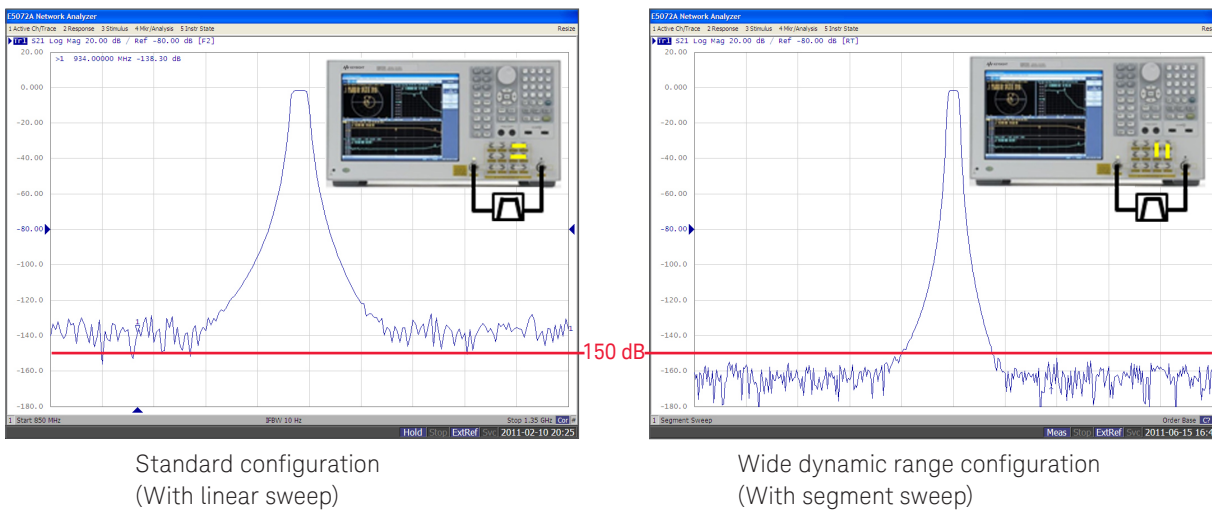

Figure 13. Dynamic range of forward measurements is improved with the configured wide dynamic range

1. When making measurement with full 2-port calibration, the dynamic range of the reverse measurement is degraded by 25 dB, with approximately up to 100 dB of dynamic range available.

## Versatile

### Faster throughput for high-attenuation devices

The wide dynamic range configuration is also beneficial for improving throughput of measurements for high-attenuating devices. Wider IF bandwidth (IFBW) can be selected to achieve the same trace noise as a standard configuration, because of extremely wide dynamic range in forward direction. For example, if dynamic range is increased with the configuration by 20 dB then 100-times wider IFBW can be selected, thus 100-times faster measurements can be performed to get the same result with trace noise.

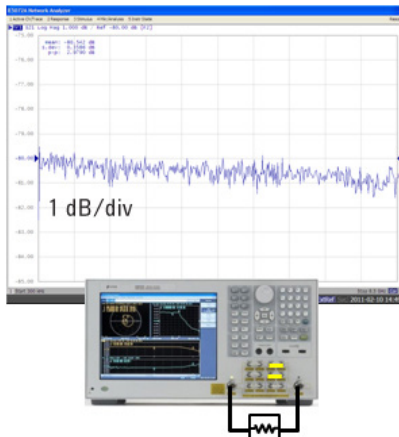

Standard Configuration  
(IFBW = 100 Hz)

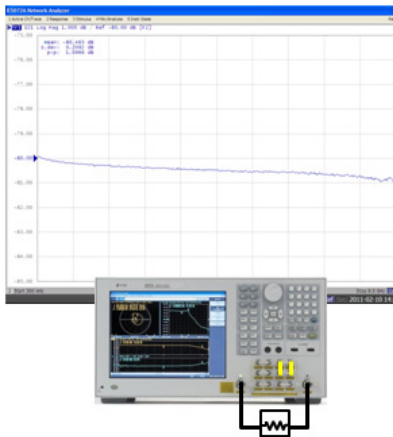

Wide dynamic range configuration  
(IFBW = 100 Hz)

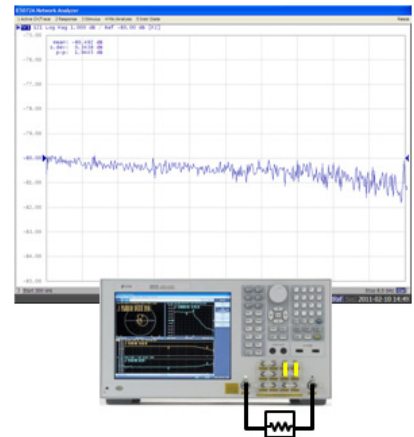

Wide dynamic range configuration  
(IFBW = 10 kHz)

Figure 14. S21 measurement of 80 dB attenuator. Comparison between the standard configuration and wide dynamic range configuration

# Versatile

## Application no. 4: Wireless power transfer analysis

Power transfer efficiency between coils or resonators is one of the key factors to improve the performance of wireless power transfer systems. The E5072A offers option 006 wireless power transfer analysis software to measure wireless power transfer efficiency between coils or resonators. In addition, the E5072A configurable test set allows to boost the power level to the input of the DUT with an external power amplifier. The direct accessibility to internal sources and receivers can cancel out the drift effect from the booster amplifier and achieve more accurate measurements at devices' actual operating conditions.

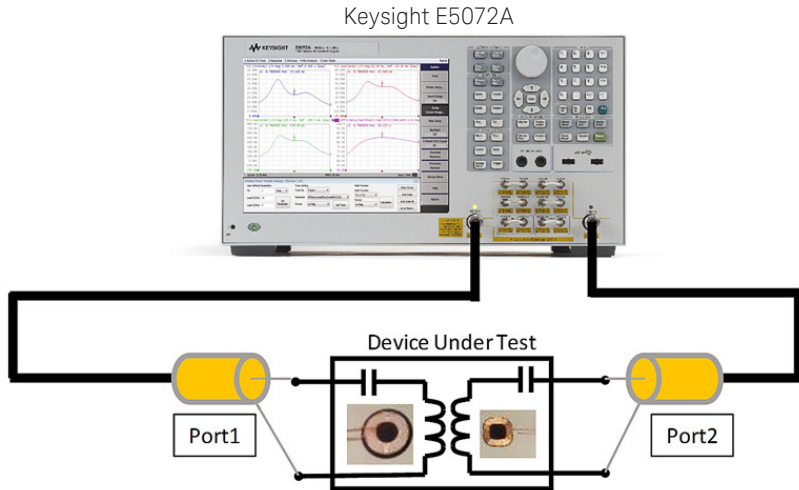

Figure 15. Measurement setup for wireless power transfer analysis

## Real-time wireless power transfer efficiency measurements

- Display wireless power transfer efficiency between coils or resonators in real-time
- Capable of setting arbitrary load impedance

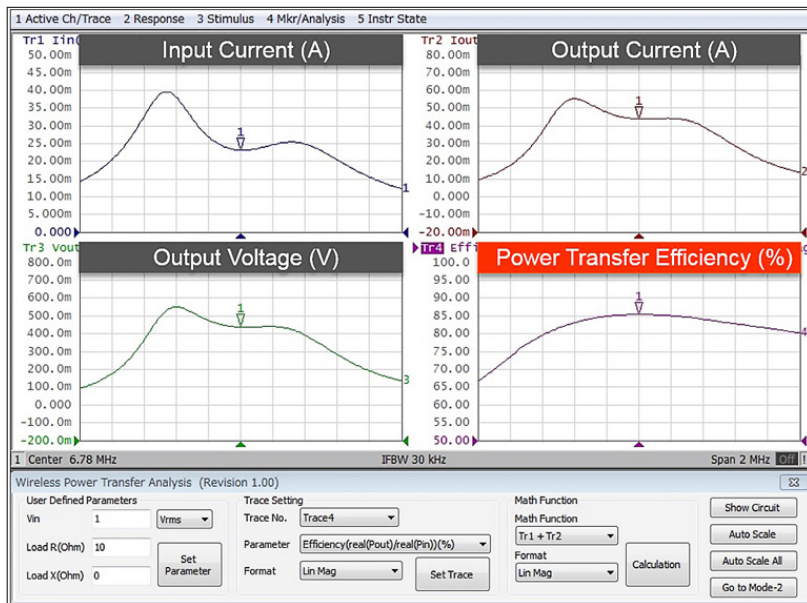

Figure 16. Real-time wireless power transfer analysis in Mode-1

# Versatile

## Advanced simulation

- 2D/3D simulation to visualize dependency of load impedance
- Network analysis data output for further circuit modeling and simulation in Keysight ADS simulator

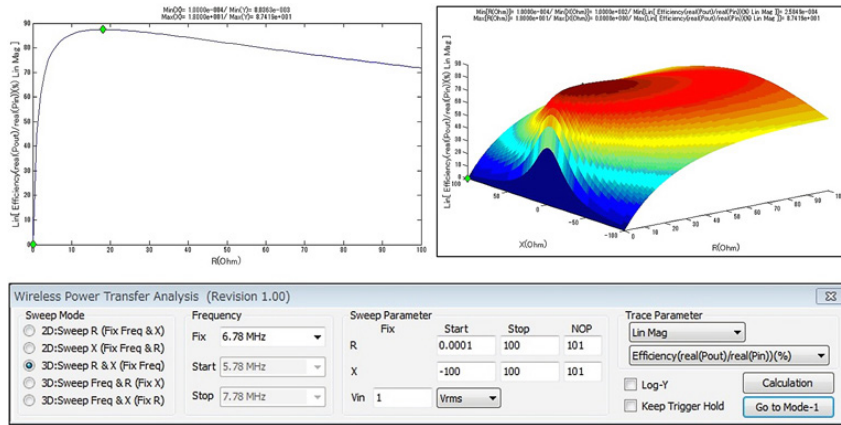

Figure 17. Advanced 2D/3D simulation in Mode-2

## High power measurements at devices' actual operating conditions

- Configurable test set available to boost output power with an external power amplifier
- The direct accessibility to all of the internal sources and receivers to cancel out the effect of temperature drift from the power amplifier

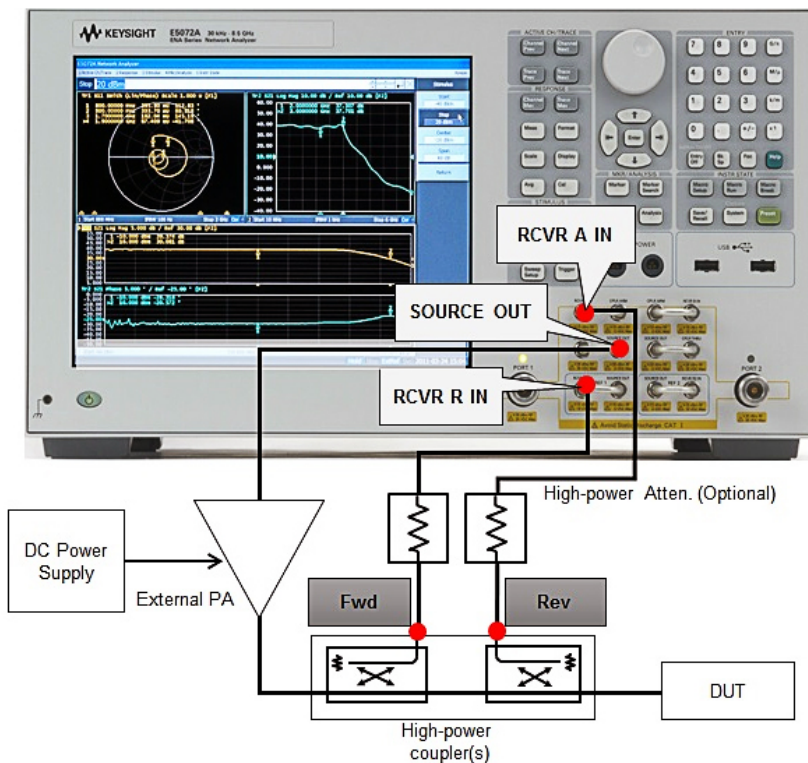

Figure 18. Setup for WPT component measurements at devices' actual operating conditions



# Fast

The E5072A is an ideal solution for manufacturers who have the most cost-sensitive needs. Its fast throughput, enhanced automated test capability, and excellent connectivity will maximize test efficiency and productivity on your production line.

## Fast throughput for manufacturing

The fast measurement speeds benefit high-volume manufacturers using automated test equipment (ATE) systems by increasing measurement throughput. This can have a significant impact on your total cost of test. The E5072A with modern data processing technology has a faster throughput than conventional network analyzers, a clear advantage over the Keysight 8753 series. The E5072A's segment sweep allows you to setup arbitrary frequency points along with IF bandwidth, number of measurement points, output power level for each port, and much more. You can maximize the throughput of your measurements by optimizing stimulus parameters. Note that the E5072A has a reverse (downward) sweep capability that allows dual directional sweep that can minimize cycle time for measurements such as near-field antenna test.



Figure 19. Measurement speed comparison: 1601 points, full 2-port cal, 1 GHz to 1.2 GHz IFBW = 6 kHz (8753ES), 500 kHz (E5071C and E5072A)

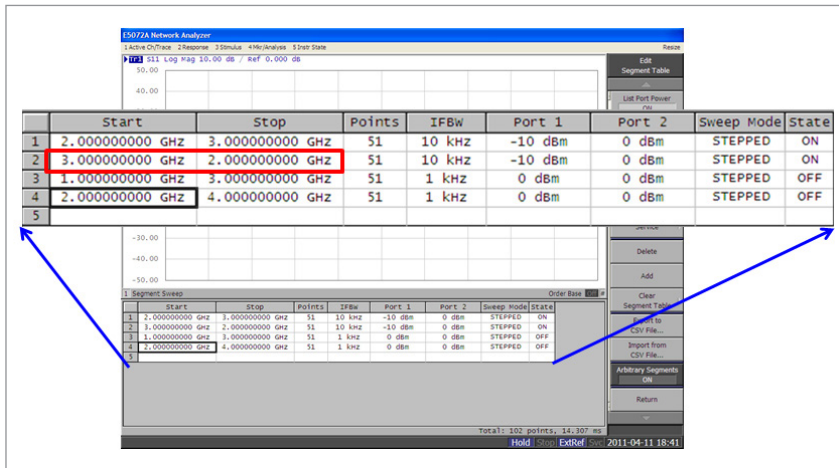

Figure 20. Arbitrary segment sweep of the E5072A. Reverse (downward) sweep can be set with a segment table

## Fast

### Fast and accurate power leveling—receiver leveling

Some active components need to be specified with a certain power level at the input or output port. When doing high-power measurements with an external booster amplifier, temperature drift of the amplifier causes variation of the input power level to the DUT giving unexpected errors in measurement results. It is desirable to know the power levels accurately and sweep the power over a desired range. It is necessary to know power levels more accurately if you want to measure non-linear behavior of your devices such as 1 dB compression point or AM to AM/AM to PM conversion.

The E5072A has a powerful function that adjusts the source power level across a frequency or power sweep using its receiver measurements. Before each measurement sweep, a variable number of background sweeps are performed to repeatedly measure power at the receiver for each stimulus point. Those power measurements are then used to adjust the source power level of the E5072A. With this receiver leveling function, you can achieve greater source power level accuracy with faster throughput compared to conventional methods using a power meter and power sensor controlled by an external system controller over GPIB.

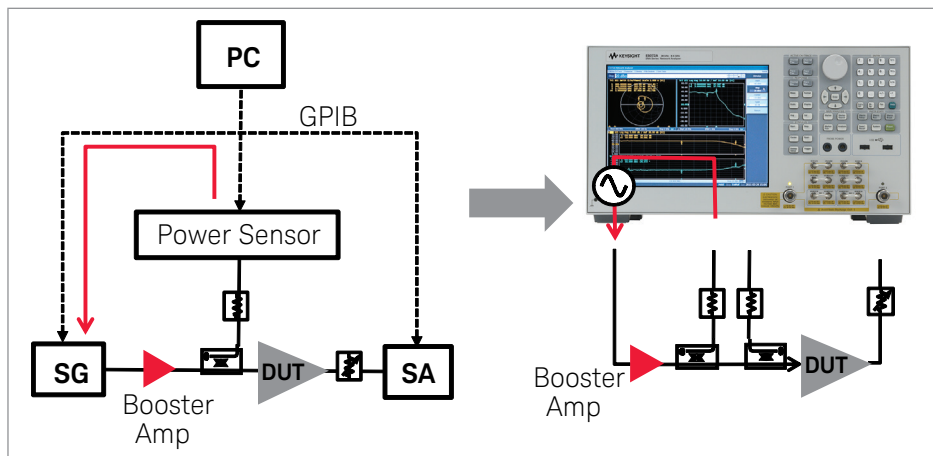

Figure 21. Fast and accurate power level adjustment with receiver leveling

# Fast

## Create your own library for fast and easy measurement

To accelerate time-to-market, you need an easy-to-use setup wizard that guides you through measurement procedures and minimize the time spent on measurement setup. The E5072A includes Microsoft VBA Macro programming capability, a time-saving tool for test automation. You can customize your interface easily to optimize the operating environment at no additional cost and you can also add automation processes. Many VBA sample programs for the ENA series are available on Keysight's website ([www.keysight.com/find/enavba](http://www.keysight.com/find/enavba)) to help you create your own program library for your applications.

The E5072A has a powerful and convenient equation editor tool that computes measurement results and adds a new trace to your measurement display. Equations can be based on any combination of existing traces or user defined parameters and constants, and your equation can be saved for later use. Any ratio measurements of absolute parameters with independent receivers of the E5072A (i.e. A/R1, R1/R2, R2/B etc.) can be calculated using the equation editor. Faster data analysis can be achieved without the use of simulators running on an external PC.

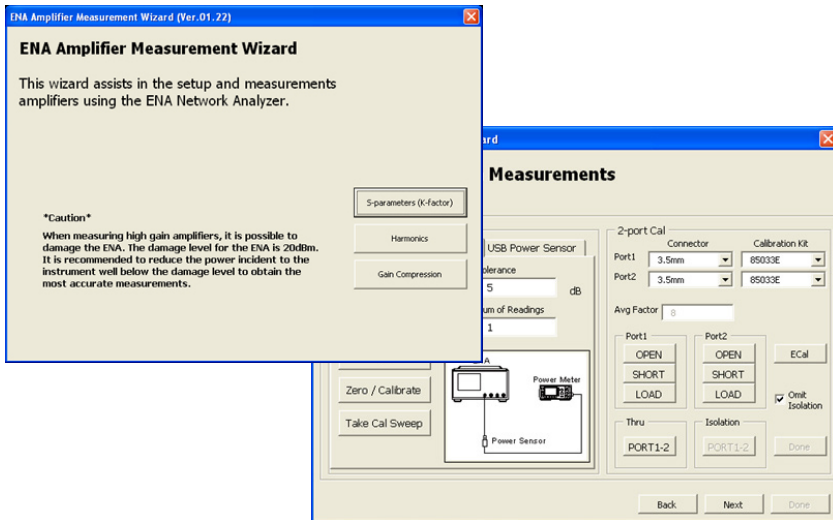

Figure 22. Step-by-step measurement wizard for amplifier measurement

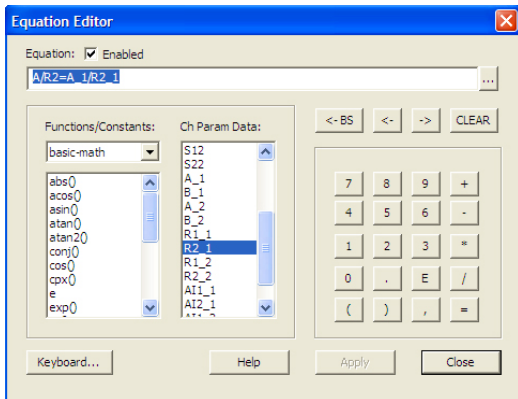

Figure 23. Ratio measurements of the E5072A's receivers (A, B, R1 or R2) using the equation editor

# Compatible

## Evolving the ENA platform

The E5072A supports all functionalities of the industry-standard E5071C ENA Series vector network analyzer including state-of-the-art calibration techniques and powerful data processes such as, fixture simulator functions, flexible marker functions, and equation editor offered with intuitive GUI on a touch screen panel.

The E5072A leverages all existing features and capabilities of the E5071C, including intuitive user interface, soft keys, pull-down menus, touch screen, an embedded help system, and the Windows-based architecture which increases efficiency of operations in R&D and manufacturing.

The E5072A's SCPI commands and user interface are fully compatible with the E5071C and 100% code compatibility is guaranteed with the E5071C firmware revision 9.61 or before. Moreover, state files created using the E5071C (2-port, up to 8.5 GHz options) with the above firmware can be recalled with any firmware version on the E5072A.

This compatibility means that you can easily make the transition to the E5072A while leveraging your investment and expertise in test software. The test software from R&D can be effortlessly transferred to manufacturing which helps you maintain past efforts, enhance current designs, and accelerate future innovations.

Note: For more details on compatibility between the E5071C and E5072A, refer to the E5072A help menu.

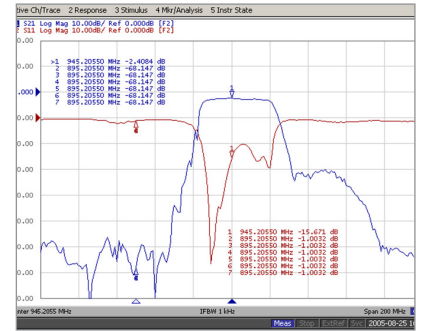

Figure 24. Flexible marker functions

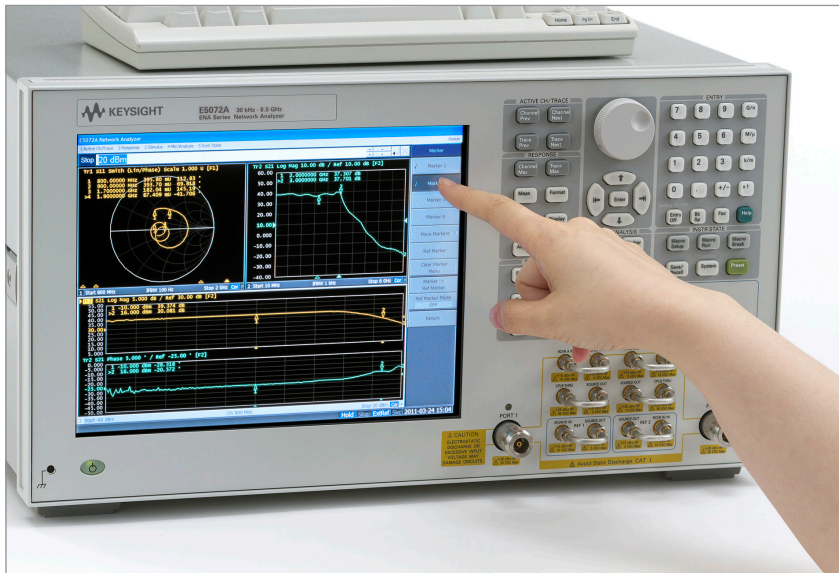

Figure 25. Intuitive GUI on touch screen display available on all ENA models



## Compatible

### Code compatibility with 8753ES

The E5072A has improved functionalities and key specifications relative to legacy network analyzers, such as the Keysight 8753 series. However, it is necessary to rewrite existing test software and redesign your test systems in order to take full advantage of E5072A's outstanding performance. Test programs developed using old compilers may need to be rewritten for the E5072A. To address this issue, the E5072A offers a 8753 code compatible mode (called cXL) which interprets the 8753ES remote programming commands for operation on the E5072A. This allows for instrument emulation and backward code capability enabling a seamless drop-in replacement in your automated test environment and minimizing transition risks.<sup>1</sup>

The E5072A footprint is exactly the same as the 8753ES and the E5071C, which makes rack system replacement effortless. The E5072A is the most compact network analyzer in its class with configurable test set capability and is ideal where space is limited.

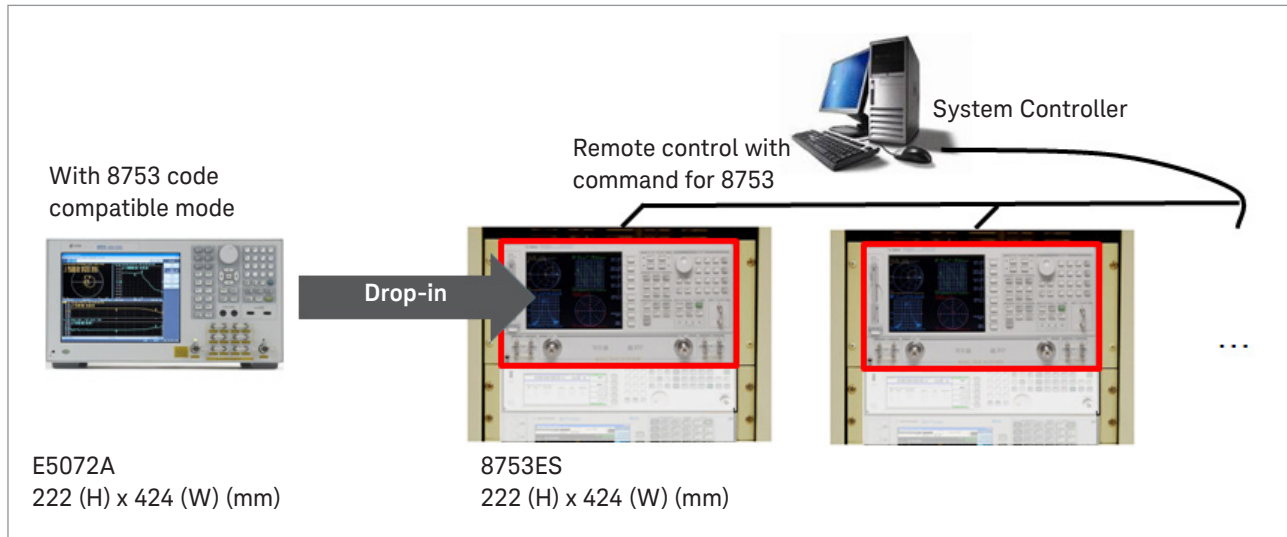

Figure 26. Minimizing switching time/cost from your existing instrument to E5072A

## Cost-effective

Designed on the cost-effective and robust ENA platform, the E5072A will minimize your initial and future investments. The E5072A is the best choice to reduce your cost of ownership.

### Robust design to reduce external damage, minimizes repair cost

It is important to reduce damage to instruments with a high-power RF level, DC voltage or electrostatic discharge (ESD). The E5072A have adopted a robust design for its internal architecture, both hardware and software. Protection circuits inside the instrument protects the E5072A from electronic stress thus dramatically reducing downtime and repair costs compared to previous generations of network analyzers. Keysight performs strict qualification tests against external damage to all RF interfaces of the E5072A. Damage levels of the E5072A's RF interfaces are listed in the data sheet, part number 5990-8002EN.<sup>1</sup>

(<http://literature.cdn.keysight.com/litweb/pdf/5990-8002EN.pdf>)

The E5072A has a power trip function that automatically turns off the source power level when excessive signal levels are detected in the internal receivers. This protects the E5072A's internal circuits from unexpected damage when making high-power measurements with an external booster amplifier.



1. Do not exceed the values of damage level provided in the data sheet or as indicated by the yellow warning labels on the analyzer.

## Cost-effective

### Upgrade your E5072A at anytime

Upgrade your E5072A's hardware and software options at any time after purchase to meet future measurement demands. Software options such as frequency offset mode (Option 008) or time domain analysis (Option 010) can be added by using a license key, which enables fast and easy upgrades to keep up with rapidly changing measurement requirements. Not ready to buy? Try out software options (E5072A Option 010 or Option 008) with a free trial license available on Keysight's website.

The E5072A's upgradability will keep your instruments up-to-date and extend the life of your test systems for future expansion.

For more details on the upgrade options, refer to the E5072A configuration guide, part number 5990-8001EN.

(<http://literature.cdn.keysight.com/litweb/pdf/5990-8001EN.pdf>)

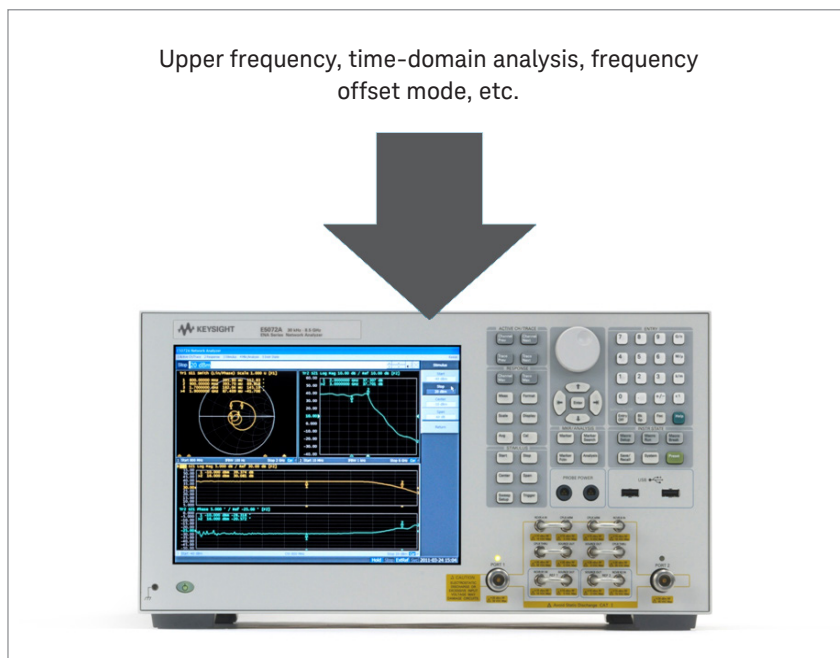
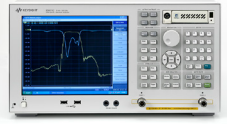

Figure 27. Add new feature any time

## Key Specifications & Features



	<b>E5072A</b>	<b>E5071C (RF options)</b>	<b>8753ES</b>
Test frequency	30 kHz to 4.5 GHz (Option 245) 30 kHz to 8.5 GHz (Option 285) (Settable down to 9 kHz)	9 k to 4.5/6.5/ 8.5 GHz (without bias-tees) 100 k to 4.5/6.5/ 8.5 GHz (with bias-tees)	30 kHz to 3 G/6 GHz
Number of ports	2-port	2- or 4-port	2-port
Configurable test set (Direct receiver access)	Yes (standard)	No	Yes (Option 014)
Max output power <sup>1</sup>	+16 dBm (spec) +20 dBm (SPD) <sup>2</sup>	+10 dBm (spec)	+8 dBm (Option 014) +20 dBm (Option 011)
Power range	-85 to +16 dBm (spec) -109 to +20 dBm (settable)	-55 to +10 dBm	-85 to +10 dBm (Standard) -85 to +8 dBm (Option 014)
Dynamic range (IFBW = 10 Hz)	> 123 dB	> 123 dB	110 dB
Extended dynamic range <sup>3</sup> (IFBW = 10 Hz)	151 dB (SPD) <sup>2</sup>	N/A	N/A
IFBW	10 Hz to 500 kHz	10 Hz to 500 kHz	10 Hz to 6 kHz
Measurement speed <sup>4</sup>	23 ms (IFBW = 500 kHz)	33 ms (IFBW = 500 kHz)	848 ms (IFBW = 6 kHz)
Bias tee current	300 mA (spec) 1 A (damage level)	200 mA (spec) 500 mA (damage level)	200 mA (spec) 1 A (damage level)
Receiver leveling	Yes	No	No
Software options	Time domain analysis, FOM, Wireless power transfer analysis	Time domain analysis, FOM, Enhanced time domain analysis	Time domain analysis, FOM
Upgradability	Yes (among all options)	Yes (among all options)	No

For additional specification details, see the Keysight E5072A Network Analyzer, Data Sheet, part number 5990-8002EN (<http://literature.cdn.keysight.com/litweb/pdf/5990-8002EN.pdf>).

1. Maximum output power is changed according to measurement frequency.
2. SPD or Supplemental Performance Data represents the value of a parameter that is most likely to occur, not guaranteed by the product warranty.
3. Extended dynamic range is calculated as the difference between the direct receiver access input noise floor and the source maximum output power.
4. 1601 points, full 2-port cal, 1 GHz to 1.2 GHz, IFBW = 500 kHz (E5072A & E5071C), 6 kHz (8753ES).



## Ordering Information

Model No.	Description
<b>E5072A</b>	<b>ENA SERIES NETWORK ANALYZER</b>
Test set options	
Option E5072A-245	2-port, 30 kHz to 4.5 GHz, configurable test set
Option E5072A-285	2-port, 30 kHz to 8.5 GHz, configurable test set
Additional feature	
Option E5072A-006	Wireless power transfer analysis
Option E5072A-008	Frequency offset mode
Option E5072A-010	Time domain analysis
Time base options	
Option E5072A-UNQ	Standard stability time base
Option E5072A-1E5	High stability time base
Hard disk drive options	
Option E5072A-017	Removable hard disk drive
Option E5072A-019	Standard hard disk drive
Calibration documentation	
Option E5072A-1A7	ISO 17025 compliant calibration
Option E5072A-A6J	ANSI Z540 compliant calibration
<b>E5072AU</b>	<b>E5072A UPGRADE KIT</b>
Option E5072AU-008	Add frequency offset mode
Option E5072AU-010	Add time domain analysis
Option E5072AU-1E5	Add high stability time base
Option E5072AU-028	Removable hard disk kit
Option E5072AU-285	From 4.5 GHz to 8.5 GHz for E5072A-245

For more details, see the Keysight E5072A Network Analyzer, Configuration Guide, part number 5990-8001EN (<http://literature.cdn.keysight.com/litweb/pdf/5990-8001EN.pdf>).

Learn more at: [www.keysight.com](http://www.keysight.com)

For more information on Keysight Technologies' products, applications or services, please contact your local Keysight office. The complete list is available at: [www.keysight.com/find/contactus](http://www.keysight.com/find/contactus)

